

Model #

1114DUETa

1-Drawer

Addison Nightstand

DUET = Natural finish

Assembly Instructions

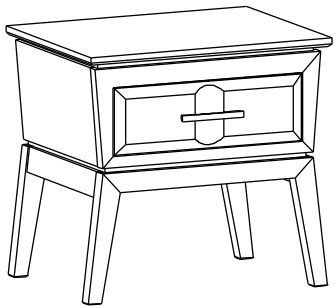

Thank you for allowing us to help you furnish your home. We are certain you will be delighted with your new furniture for many years to come.

IMPORTANT NOTES:

- For normal household use only. *Not* recommended for commercial use.
- Do not climb, sit or stand on this piece of furniture.
- Do not overload the drawers.
- Unload items before you move this unit.

WARNING

Drilling, sawing, sanding or machining wood products can expose you to wood dust, a substance known to the state of California to cause cancer. Avoid inhaling wood dust or use a dust mask or other safeguards for personal protection.

For more information go to: www.p65warnings.ca.gov/wood

This product can expose you to chemicals, including formaldehyde, which are known to the State of California to cause cancer.

For more information go to: www.p65warnings.ca.gov/furniture

DESIGN SUBJECT TO CHANGE WITHOUT NOTICE.

CUSTOMER SERVICE

If you ever have questions about your furniture, please do not hesitate to contact us. In the unlikely event you need a replacement part; we can make those parts available through an authorized Whittier Wood Furniture dealer. If you cannot order replacement parts through your dealer, please contact our customer service department.

Hours: Our friendly customer service staff can be reached:

Monday-Friday 8:00 a.m. to 5:00 p.m. (Pacific Time).

You may leave a message 24 hours a day, seven days a week.

Customer Service: 800-653-3336 • **Outside the U.S.:** 541-687-0213

Fax: 541-687-2060 • **Email:** info@whittierwood.com

Whittier
Wood 
FURNITURE

P.O. Box 2827
Eugene, OR 97402 USA

Production Code:











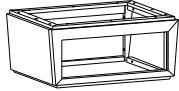

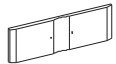

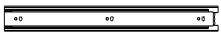

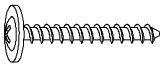
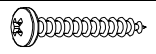

VN

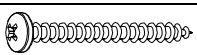
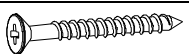
05/18

1114DUETa 1-Drawer Addison Nightstand

Parts List

Please identify the parts and check that quantities received match those on this list.
If you need to replace a part, refer to the following letter and part name.

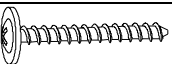
Part	Description		Quantity
Aa	Top Assembly (attached)		1
Ba	Case		1
C	Drawer Box (inserted)		1
D	Drawer Face (installed)		1
E	Base (attached)		1
F	16" Drawer Slides (pre-installed sets)		1
G	#6 x 3/4" Philtruss Screw (inserted)		6
H	#6 x 3/4" Brass Flat Head Screw (inserted)		20
I	#6 x 1/2" Philtruss Screw (inserted)		6
J	#8 x 1-1/8" Lo-Profile Screw (inserted)		7
K	#8 x 1" Pan Head Screw (inserted)		4
L	#8 x 1-1/4" Pan Head Screw (inserted)		6
M	#8 x 7/8" Black Lo-Profile Screw (inserted)		13
N	#8 x 1-3/4" Pan Head Screw (inserted)		8
O	#8 x 1-5/8" Black Screw (inserted)		8
Q	#8 x 1-5/8" Machine Screw Tuscan (installed)		2
S	1/4" x 20mm Insert Nut (inserted)		4
T	5/32" x 10mm Insert Nut (inserted)		2
U	Black Walnut Pull (attached)		1
V	Front 4-Hole Bracket (attached)		2
W	Back 6-Hole Bracket (attached)		2
X	Small Adjustable Glide (installed)		4
Y	#8 x 1-3/8" Lo-Profile Screw (inserted)		12

1114DUETa 1-Drawer Addison Nightstand

Assembly Instructions

Tool Required: Phillips Screwdriver

1. Remove screws from the plywood supports and side aprons. Recycle or discard. See Figure 1.

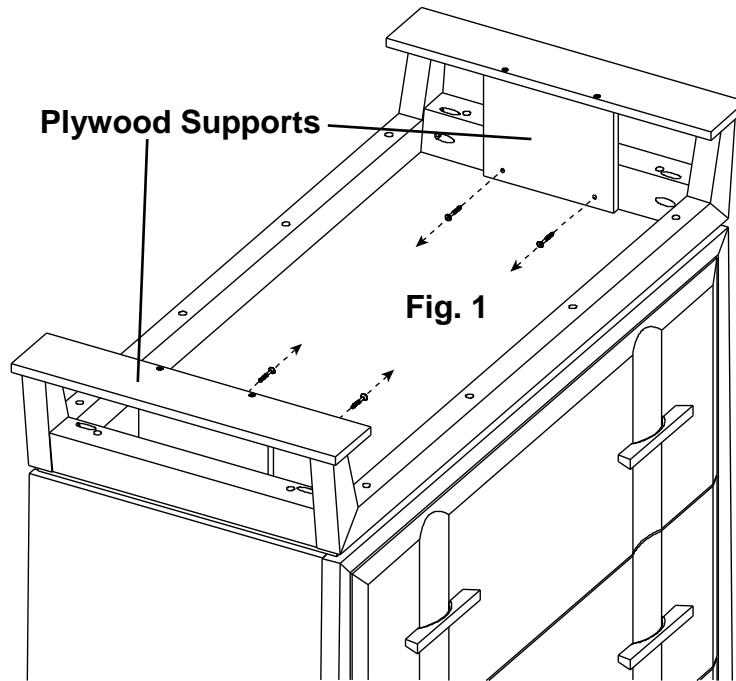

Fig. 1

2. Place the unit at its final destination. Rotate the Small Adjustable Glides (X) on the bottoms of the legs until the unit is level. See Figure 2.

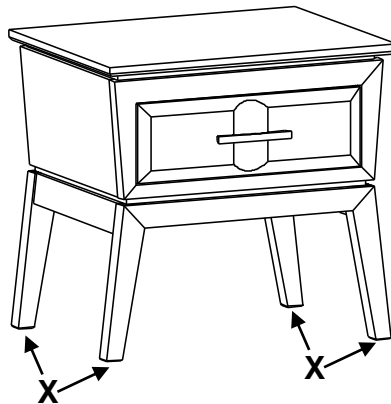

Fig. 2