

# ASSEMBLY INSTRUCTIONS

---

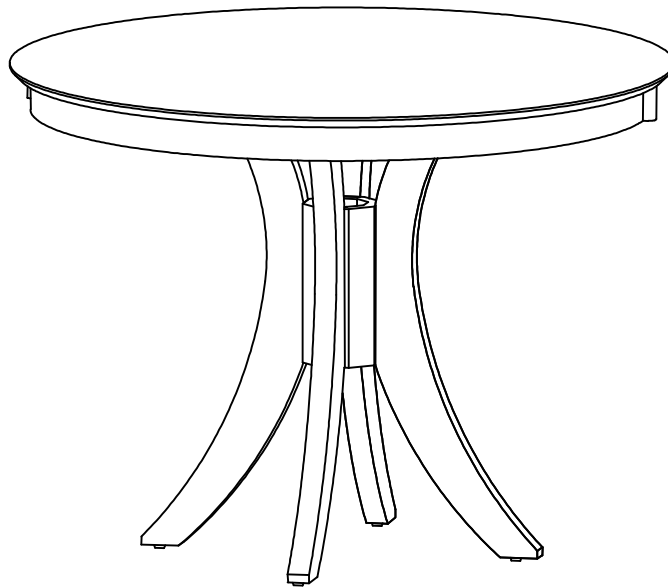

T-148RT AND T-148B-30



T-148RT AND T-148B-36

---

Description	: 48 IN ROUND SIENA TABLE
Item No.	: T-148RT AND T-148B-30 OR T-148B-36 (PACKED IN SEPARATE BOX)

**ITEM NO.: T-148RT AND T-148B-30 OR T-148B-36**  
(PACKED IN SEPARATE BOX)  
**REVISED DEC 05, 2015**

**Printed in Vietnam**

## BEFORE ASSEMBLY

Thank you for purchasing this quality product. This product has been designed for easy assembly and constructed for durability. All parts were checked prior to packaging to insure quality. Prior to beginning assembly, however, make sure all parts and hardware are included and free of obvious defect. If a part is missing or defective, please contact the store where purchased. If hardware is missing, or you need help with assembly, please call toll free 888-944-8396.

### IMPORTANT NOTE:

- Place all wooden parts on a clean and smooth surface such as a rug or carpet to avoid the parts from being scratched.
- Remove all wrapping material, including staples & packing straps before you start to assemble.
- DO NOT tighten all screws and bolts until completely assembled.
- Keep all hardware parts out of reach of children.

### WARNING:

Long exposure to rubber or soft plastic may cause a chemical reaction and damage the finish of your table. Protect the surface of the table with cloth if you are using any product with rubber feet or base.

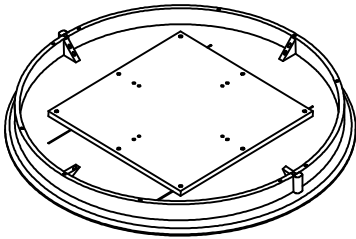

## PART LIST T-148RT

When unpacking, please be careful not to discard any parts with the packaging. Before continuing, please make sure you have the following parts:

NO	Description	Qty	Sketch
A	Top	1	



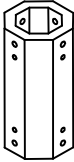

## PART LIST T-148B-30 OR T-148B-36

When unpacking, please be careful not to discard any parts with the packaging. Before continuing, please make sure you have the following parts:

NO	Description	Qty	Sketch	NO	Description	Qty	Sketch
B	Pedestal	1		C	Leg	4	

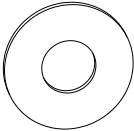
## HARDWARE LIST

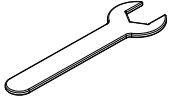
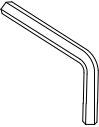
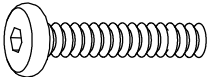
When unpacking, please be careful not to discard any parts with the packaging. Before continuing, please make sure you have all of the following hardware:

NO	Description	Qty	Sketch	NO	Description	Qty	Sketch
1	Large Flat washer ( $\Phi 8.5 \times \Phi 19 \text{mm}$ )	8		2	Large Lock washer ( $\Phi 8.5 \times \Phi 13 \text{mm}$ )	8	
3	Hexagon nut (M8x13mm)	8		4	Wrench (M13mm)	1	
5	Allen key (M4x80mm)	1		6	Bolts (M6 x 35mm)	4	
7	Small Lock washer ( $\Phi 6.5 \times \Phi 11 \text{mm}$ )	4		8	Small flat washer ( $\Phi 6.5 \times \Phi 13 \text{mm}$ )	4	

**NOTE : HARDWARE IS PACKED IN CARTON T-148B-30 OR T-148B-36**

**ITEM NO.: T-148RT AND T-148B-30 OR T-148B-36**  
 (PACKED IN SEPARATE BOX)  
 REVISED DEC 05, 2015

**Printed in Vietnam**

## STEP 1

Attach the legs (C) to pedestal (B) with nuts (3), and washers (2) and (1) as shown below. Tighten with the wrench (4).

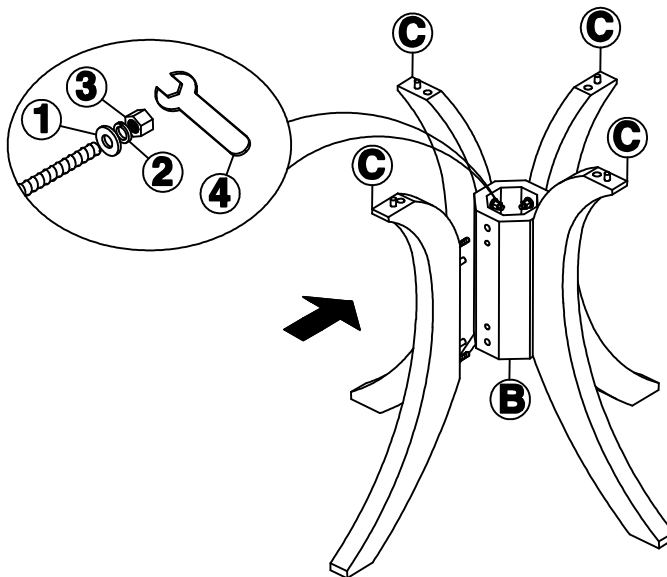

## STEP 2

Use the Allen key (5) to loosen the bolts and washers, remove the plate underneath the table top.

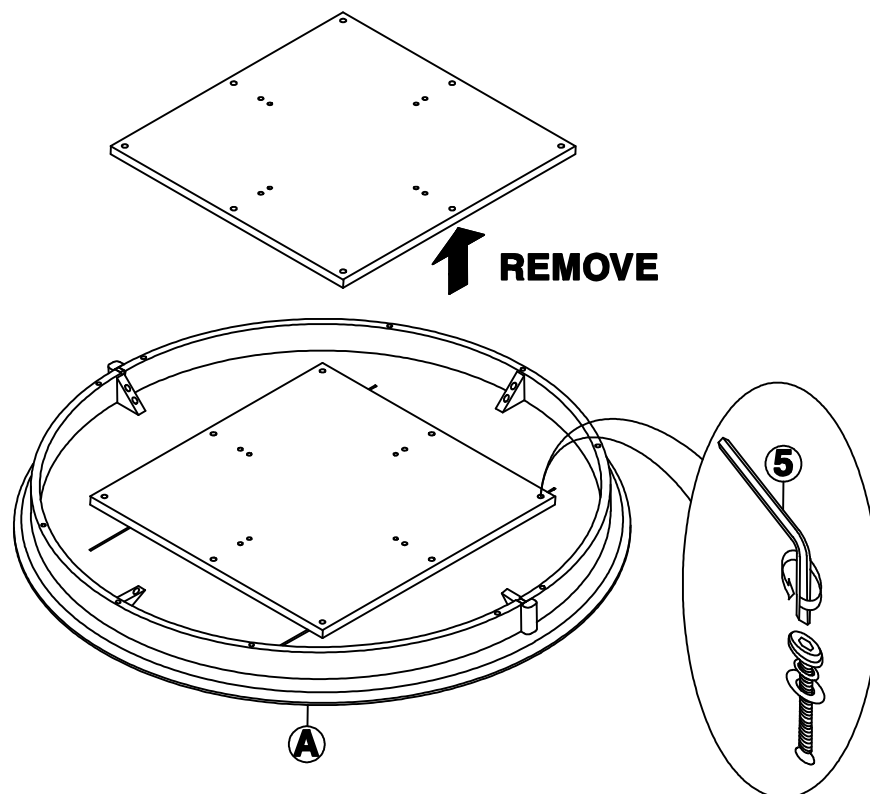

ITEM NO.: T-148RT AND T-148B-30 OR T-148B-36  
(PACKED IN SEPARATE BOX)  
REVISED DEC 05, 2015

Printed in Vietnam

## STEP 3

Place the plate on top of the legs (C), attach with bolts (6), and washers (7) and (8) as shown below. Tighten with the Allen key (5).

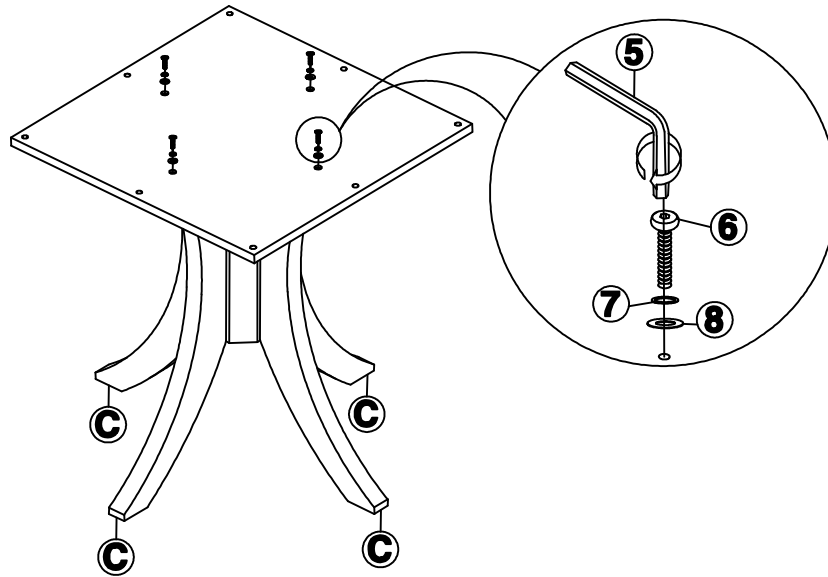

## STEP 4

Carefully place the plate, pedestal and legs (from step 3) on the bottom side of the table top. Attach the table top to the plate with bolts and washers (from step 2) as show below. Tighten with the Allen key (5).

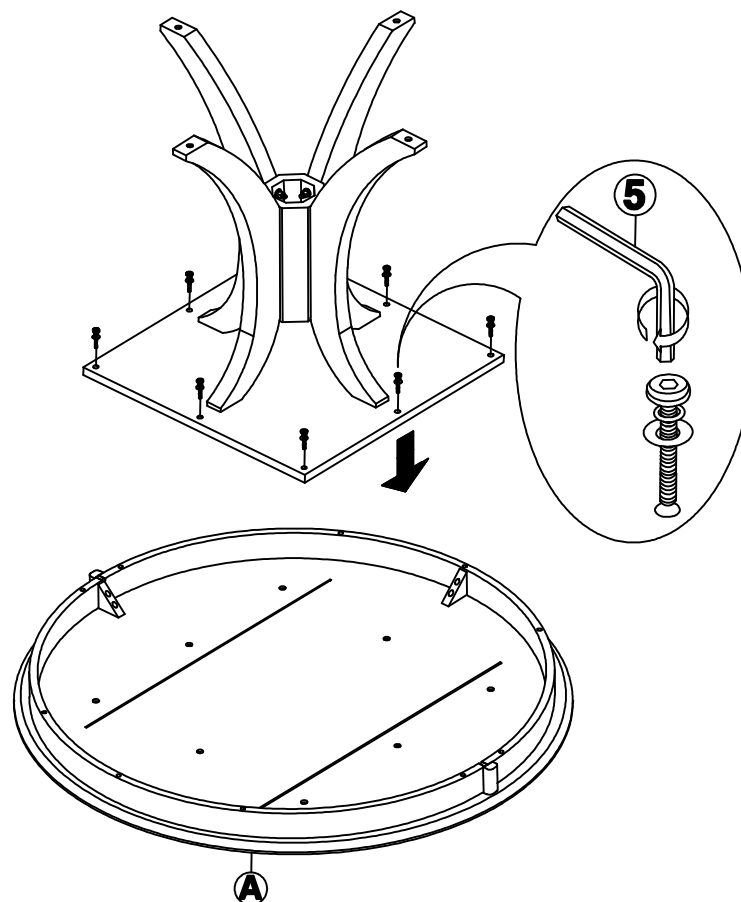

ITEM NO.: T-148RT AND T-148B-30 OR T-148B-36  
(PACKED IN SEPARATE BOX)  
REVISED DEC 05, 2015

Printed in Vietnam