

ASSEMBLY INSTRUCTIONS



Description : 42X42X60 CONTEMPORY TABLE
Item No. : T-42RX

BEFORE ASSEMBLY

Thank you for purchasing this quality product. This product has been designed for easy assembly and constructed for durability. All parts were checked prior to packaging to insure quality. Prior to beginning assembly, however, make sure all parts and hardware are included and free of obvious defect. If a part is missing or defective, please contact the store where purchased. If hardware is missing, or you need help with assembly, please call toll free 888-944-8396.

IMPORTANT NOTE:



- Place all wooden parts on a clean and smooth surface such as a rug or carpet to avoid the parts from being scratched.
- Remove all wrapping material, including staples & packing straps before you start to assemble.
- DO NOT tighten all screws and bolts until completely assembled.
- Keep all hardware parts out of reach of children.

WARNING:

Long exposure to rubber or soft plastic may cause a chemical reaction and damage the finish of your table. Protect the surface of the table with cloth if you are using any product with rubber feet or base.

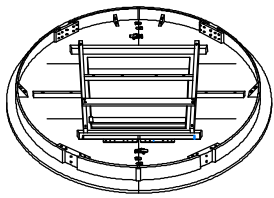

PART LIST

When unpacking, please be careful not to discard any parts with the packaging. Before continuing, please make sure you have the following parts:

NO	Description	Qty	Sketch	NO	Description	Qty	Sketch
A	Top	1		B	Leg	4	

HARDWARE LIST

When unpacking, please be careful not to discard any parts with the packaging. Before continuing, please make sure you have all of the following hardware:

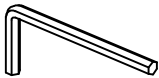
NO	Description	Qty	Sketch	NO	Description	Qty	Sketch
1	Bolt (M8x45mm)	8		2	Lock washer (Φ8.5x13mm)	8	
3	Flat washer (Φ8.5x19mm)	8		4	Allen Key (4x80mm)	1	

ITEM NO.: T-42RX
REVISED AUG 27, 2014

Printed in Vietnam

STEP 1

Attach legs (B) to the top (A) with bolts (1), and washers (2) and (3) as shown below. Tighten with Allen key (4).

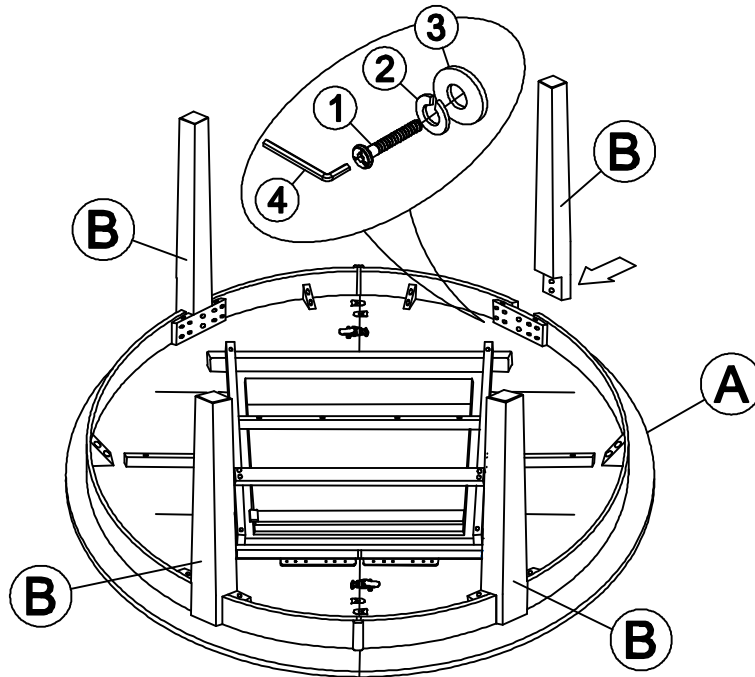

STEP 2

Unlock the table top from both sides underneath the top as shown below. Pull the 2 parts of the table top apart.

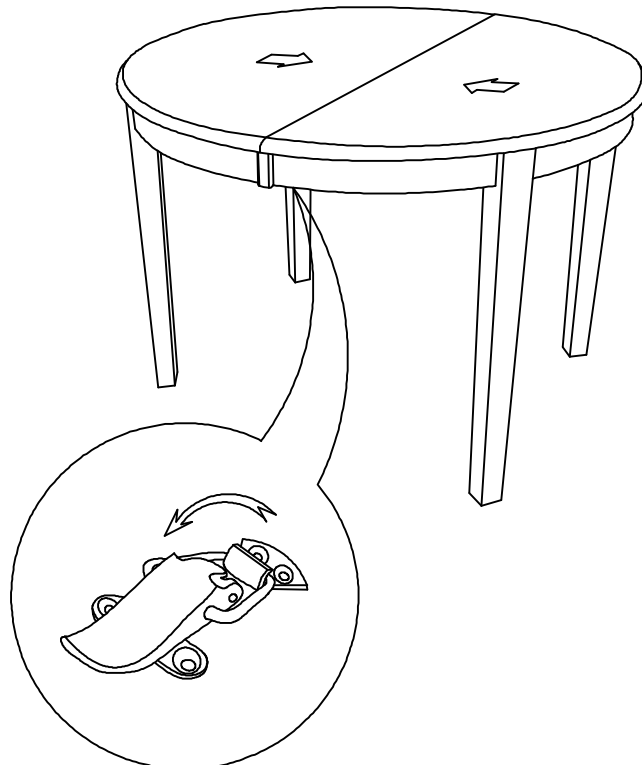

STEP 3

Place the leaf in the center of the open table top. Push the table top closed. Lock the mechanism underneath 2 sides of the table top as shown below.

