

Model #

# 1161RLN

## Bryce 4 Drawer Chest

RLN = Ridgeline finish  
*Assembly Instructions*

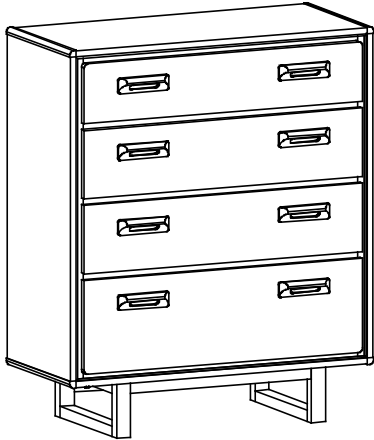

*Thank you for allowing us to help you furnish your home. We are certain you will be delighted with your new furniture for many years to come.*

### IMPORTANT NOTES:

- Wood can be susceptible to changing color over time when exposed to strong sunlight. Use window shades, drapes or blinds to protect your furniture. To help the surface age evenly and avoid dark and light spots, periodically move items to expose the entire surface to an even amount of light so it may develop a uniform patina.
- For normal household use only. *Not* recommended for commercial use.
- Do not climb, sit or stand on this piece of furniture.
- Do not overload the drawers.
- Unload items before you move this unit.
- This assembly requires two people.

### WARNING

**Children have died from furniture tipover. To reduce the risk of furniture tipover:**

- ALWAYS install tipover restraint provided.
- NEVER put a TV on this product.
- NEVER allow children to stand, climb or hang on drawers, doors or shelves.
- NEVER open more than one drawer at a time.
- DO NOT defeat or remove the drawer interlock system.
- Place heaviest items in the lowest drawers.

**Use of tipover restraints may only reduce, but not eliminate, the risk of tip over.**

**Attention:** Attached to the bottom of or included with this unit is a tipping restraint kit. When you receive your furniture, be sure to find and install the tipping restraint as instructed in the kit. If you cannot locate the restraint, please contact us immediately for replacement.

Drilling, sawing, sanding or machining wood products can expose you to wood dust, a substance known to the state of California to cause cancer. Avoid inhaling wood dust or use a dust mask or other safeguards for personal protection.

For more information go to: [www.p65warnings.ca.gov/wood](http://www.p65warnings.ca.gov/wood)

This product can expose you to chemicals, including formaldehyde, which are known to the State of California to cause cancer. For more information go to: [www.p65warnings.ca.gov/furniture](http://www.p65warnings.ca.gov/furniture)

**DESIGN SUBJECT TO CHANGE WITHOUT NOTICE.**

### CUSTOMER SERVICE

If you ever have questions about your furniture, please do not hesitate to contact us. In the unlikely event you need a replacement part; we can make those parts available through an authorized Whittier Wood Furniture dealer. If you cannot order replacement parts through your dealer, please contact our customer service department.

**Hours:** Our friendly customer service staff can be reached:  
**Monday-Friday 8:00 a.m. to 5:00 p.m. (Pacific Time).**  
You may leave a message 24 hours a day, seven days a week.

**Customer Service:** 800-653-3336 • **Outside the U.S.:** 541-687-0213  
**Fax:** 541-687-2060 • **Email:** [info@whittierwood.com](mailto:info@whittierwood.com)

**Whittier**  
**Wood**  
**FURNITURE**

P.O. Box 2827  
Eugene, OR 97402 USA

Production Code:











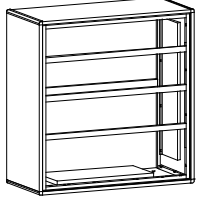
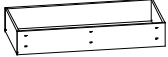
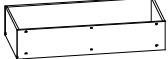
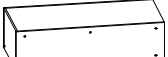



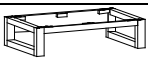
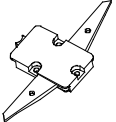

VN

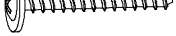
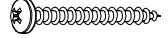
10/19

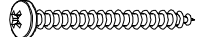





# 1161RLN Bryce 4 Drawer Chest

## Parts List

Please identify the parts and check that quantities received match those on this list.  
If you need to replace a part, refer to the following letter and part name.

Part	Description		Quantity
A	Case		1
B	Upper Drawer Box (inserted)		1
C	Center Drawer Box (inserted)		2
D	Lower Drawer Box (inserted)		1
E	Upper Drawer Face (installed)		1
F	Center Drawer Face (installed)		2
G	Lower Drawer Face (installed)		1
H	Base (attached)		1
I	Anti-Tip Snapper (attached)		1
J	Drawer Clip (attached)		2
K	14" Drawer Slides (pre-installed sets)		4
L	#6 x 3/4" Philtruss Screw (inserted)		27
M	#6 x 1/2" Philtruss Screw (inserted)		30
N	#8 x 1-3/8" Lo-Profile Screw (inserted)		6
O	#8 x 1-1/4" Pan Head Screw (inserted)		38
P	#8 x 7/8" Black Lo-Profile Screw (inserted)		24
Q	#8 x 1-3/4" Pan Head Screw (inserted)		18
R	#7 x 1-1/2" Black Pan Head Screw		8
S	#8 x 1-1/2" Machine Screw Tuscan (installed)		16
T	5/16" Flat Washer (inserted)		4
U	1/4" x 20mm Insert Nut (inserted)		4
V	5/16" x 35mm Hex Bolt (inserted)		4

**1161RLN Bryce 4 Drawer Chest**  
*Parts List*

<b>Part</b>	<b>Description</b>		<b>Quantity</b>
W	5/16" x 10mm T-Nut (inserted)		4
X	5/32" x 10mm Insert Nut (inserted)		16
Y	Pull (attached)		8
ZA	Brass Plate (attached)		8
ZB	Small Adjustable Glide (installed)		4
TS	Furniture Tipping Restraint (attached)		1 set

# 1161RLN Bryce 4 Drawer Chest

## Assembly Instructions

### Tools Required: Phillips Screwdriver, Pencil.

1. This piece of furniture includes a drawer interlock system allowing only one lower drawer to be open at a time. This is a safety feature to reduce the risk of tip over. Do not defeat or remove the drawer interlock system.
2. Place the chest at its final destination. Rotate the Small Adjustable Glides (ZB) on the bottoms of the legs until the unit is level. See Figure 2.

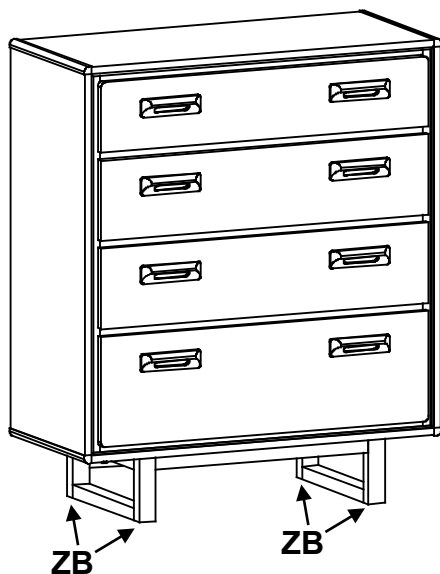
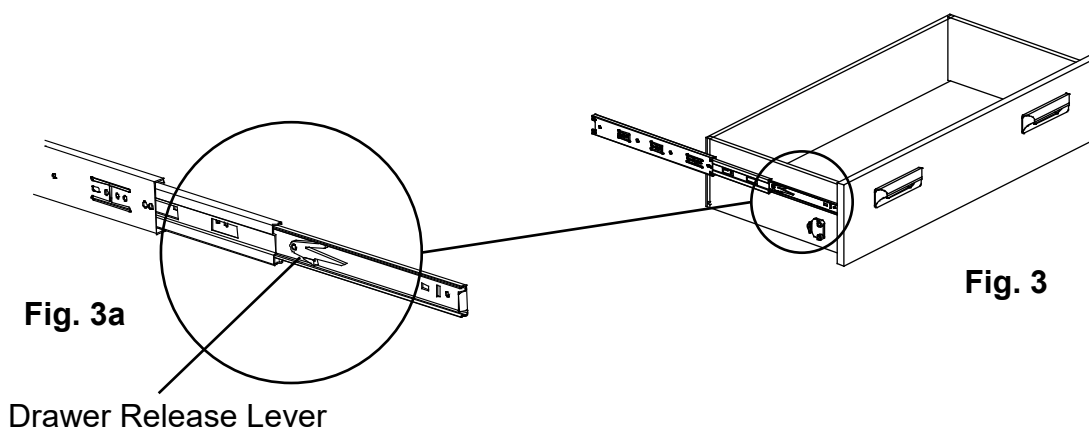

Fig. 2

3. If you need to remove your drawers, pull up on the left Drawer Release Lever while pushing down on the right Drawer Release Lever and pull out the drawer. See Figures 3 and 3a. Note where each drawer came from to make sure you place them back into their correct positions.



## 1161RLN Bryce 4 Drawer Chest

### *Assembly Instructions*

---

- When removing drawers from furniture featuring the Anti-Tip Drawer Interlock System it is important that the drawer be installed back in its original location. Numbers and letters are stamped on the back of the drawers. Stamping sequence starts at the bottom, moves to the top and designated left or right.

Drawer back stamping example:

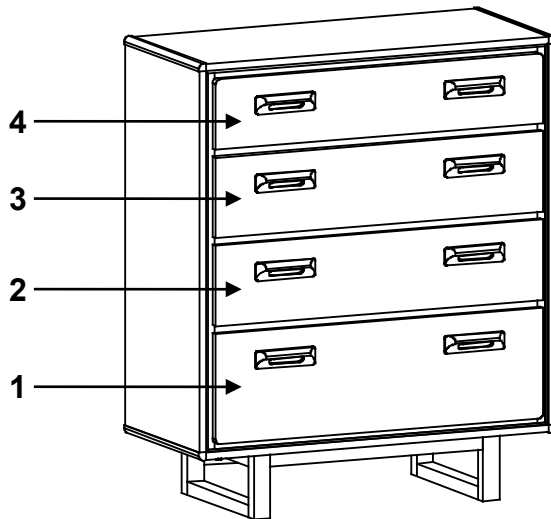
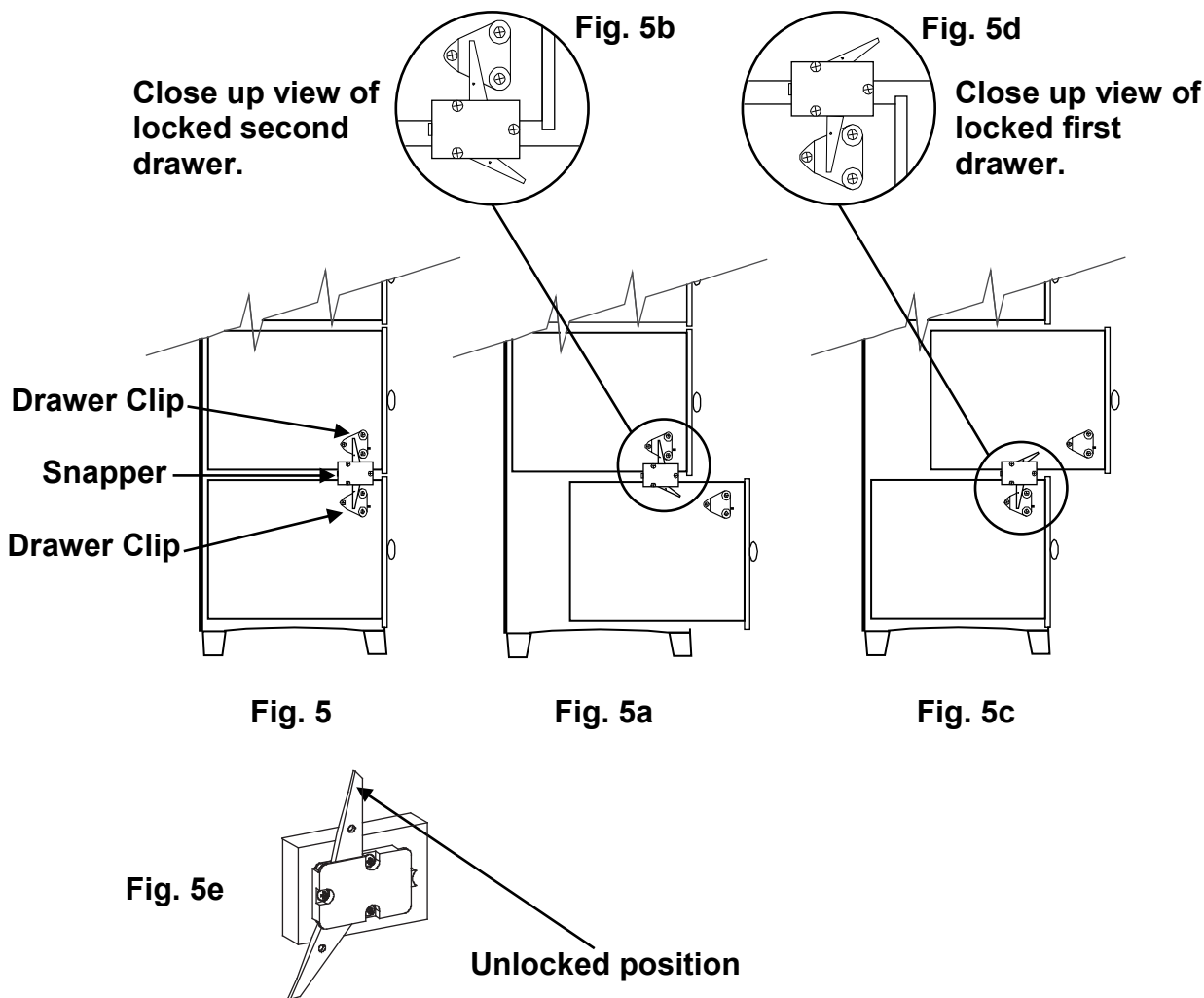

**Fig. 4**

# 1161RLN Bryce 4 Drawer Chest

## Assembly Instructions

5. Example; if you want to remove the First Drawer and Second Drawer from the chest; remove the Second Drawer first. When you remove this drawer the upper arm on the Anti-Tip Snapper for that side will be pulled forward. See Fig. 5d. As long as this arm is angled toward the front of the case, you cannot remove the First Drawer. Move the upper arms of the Anti-tip Snapper to the unlocked position as shown in Figure 5e. You can then remove the First Drawer as shown in Step 3. To reinstall the drawers, install the First Drawer then move the upper arm of the Anti-tip Snapper to the forward locked position. Now you can reinstall the Second Drawer.







# Furniture Tipping Restraint Instructions



## Safety First! Anchor It!

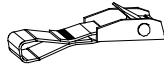
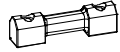

Before you begin this assembly, identify each part and make sure the quantities received match what is on this list. If you need to replace a part, contact Whittier Wood Furniture customer service and refer to the following list for its name and letter code.

Part	Description		Quantity
A	Cam Buckle and Short Strap (installed)		1
B	Plastic Bracket (installed)		1
C	1" x 1000mm Long Strap (installed)		1
D	#8 x 3" Pan Head Screw		2
E	#10 x 1" Oval Head Screw (inserted)		1
F	Washer		1

**If you have a stone or tile floor or do not wish to drive screws into the corner of the baseboard and floor see the instruction included inside the tipping restraint kit for an alternate installation.**

- Decide where you want to place the piece of furniture in your room. Mark the baseboard with a pencil mark directly behind the location where the tipping restraint is attached to your item. Move the item away from the wall far enough to allow you to access the spot where the baseboard meets the floor. Position the straps and Plastic Bracket (B) as shown in Figures 6 and 6a with the angled corners of the Plastic Bracket (B) firmly placed against the seam of the baseboard and floor. Attach by driving #8 x 3" Pan Head Screws (D) through the holes in the Plastic Bracket (B) into the seam below the baseboard where it meets the floor. See Figures 6 and 6a.

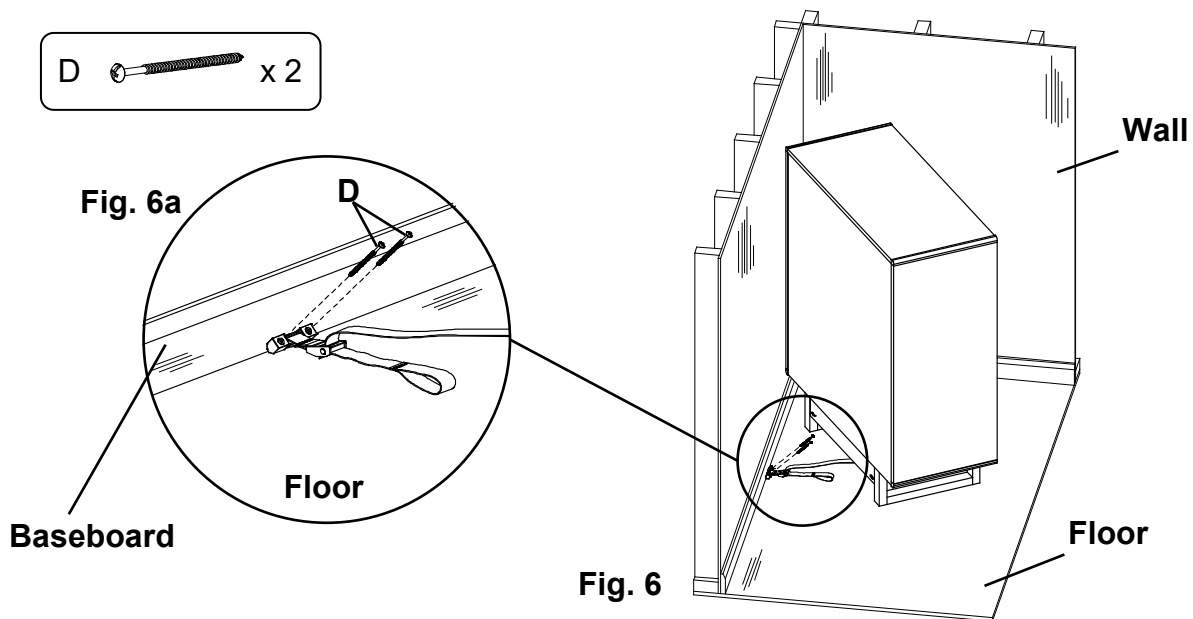

# 1161RLN Bryce 4 Drawer Chest

## Assembly Instructions

7. Move the item back into position against the wall and reach underneath the piece of furniture to grasp the loop in the free end of the strap. Pull the free end of the strap until portion between the Cam Buckle (A) and the back apron of the item is tight. See Figures 7 and 7a. If you need to move the piece of furniture reach beneath and locate the buckle which connects the two sections of the strap and depress the release lever, then pull on the section of strap that is between the buckle and the back apron of the furniture until there is enough slack to allow you to pull the item away from the wall.

